

TRBA and TFBA



TRBA Rounded Roof Edge
Here shown with side panel

TFBA Straight Roof Edge
Here shown with side panel

Metal Color Choices

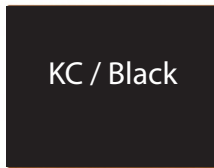
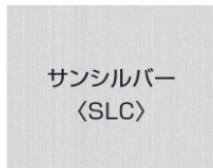
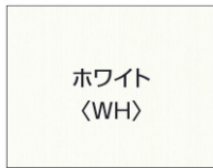

Brown Panel



Blue Panel



Frosted Panel

Roof Panel Choices



Frosted Heat-cut



Self-cleaning Panel

BEST!

Available Projections:
2.47' / 3.13' / 4.11'
Available Length:
3.4' to Endless

	Brown Panel	Blue Panel	Frosted Panel	Frosted HC	Self-cleaning
Heat-cut Ratio	45%	40%	16%	70%	15%
Visible Light	34%	20%	88%	76%	87%
UV-Ray Cut	100%	100%	100%	100%	100%



Japanese Aluminum Awnings



メニーウェルA (600タイプ)



1階設置

UC/サイズ9030S/FB型/柱なし式

メニーウェルA (600タイプ)



2階設置

屋根側面パネル

屋根側面パネルの取り付けが可能です。

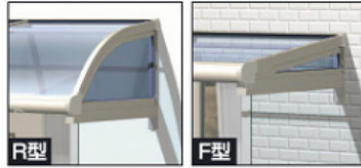

R型

F型

Support braces every 3 panels

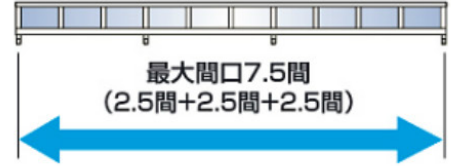

Support brace-locations are flexible

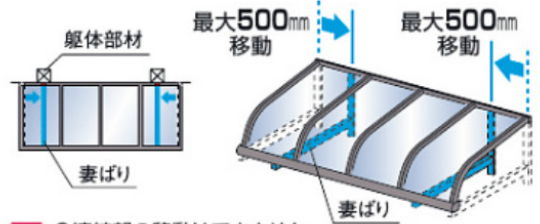

- 連結部の移動はできません。
- 妻ばりを移動した場合、屋根側面パネルの取り付けはできません。



Straight Edge Style

Rounded Edge Style



Rounded Edge Style

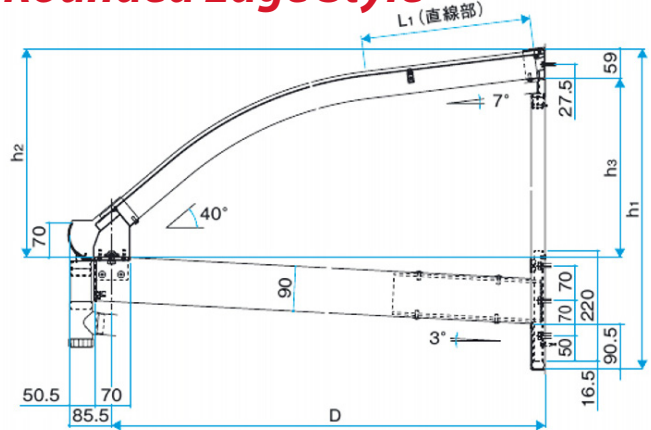

●TRBA型 (出幅2~4尺)

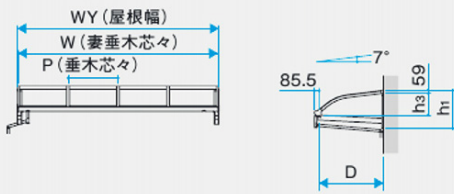

●TRBB型 (出幅2~4尺)

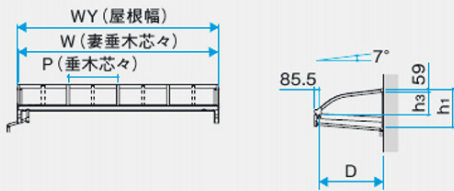

●正面図<600タイプ>

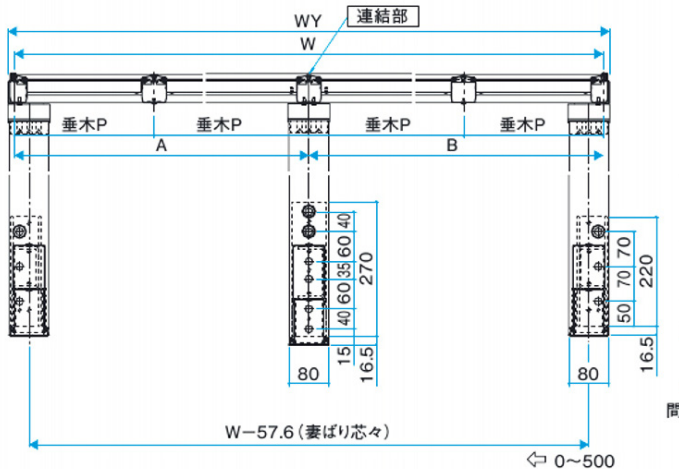

■間口 (W・WY)、垂木 (P)

(単位:mm)

呼称間口	W	WY	垂木P		
			600タイプ	1500タイプ	
関東間	0.5間 (30)	909	936	909	454.5
	1.0間 (60)	1818	1845		
	1.5間 (90)	2727	2754		
	2.0間 (12)	3636	3663		
	2.5間 (15)	4545	4572		
	3.0間 (18)	5454	5481		
	3.5間 (21)	6363	6390		
	4.0間 (24)	7272	7299		
	4.5間 (27)	8181	8208		
	5.0間 (30)	9090	9117		
メーターモジュール	0.5間 (100)	1000	1027	1000	500
	1.0間 (200)	2000	2027		
	1.5間 (300)	3000	3027		
	2.0間 (400)	4000	4027		
	2.5間 (500)	5000	5027		
	3.0間 (600)	6000	6027		
	3.5間 (700)	7000	7027		
	4.0間 (800)	8000	8027		
	4.5間 (900)	9000	9027		
	5.0間 (1000)	10000	10027		

■<600タイプ> 出幅 (D)、直線部 (L1)、高さ (h1・h2・h3)

(単位:mm)

呼称出幅	D	L1	h1	h2	h3
2尺 (20)	670	139	606	連結部:626	393.5
3尺 (30)	870	340.5	641	連結部:661	418
4尺 (40)	1170	643	694	連結部:713.5	455

●側面図<1500タイプ>

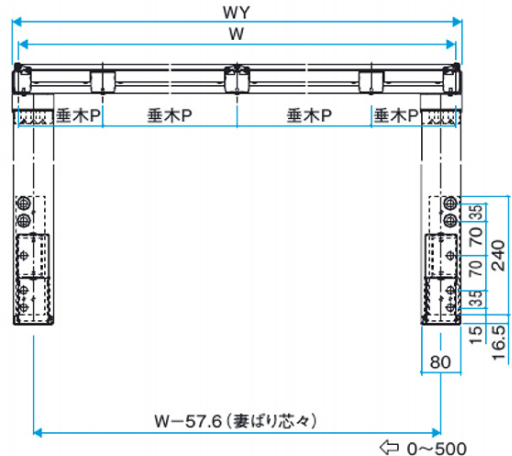

Measurements in millimeters



Japanese Aluminum AWNINGS

Measurements in millimeters



Straight Edge Style

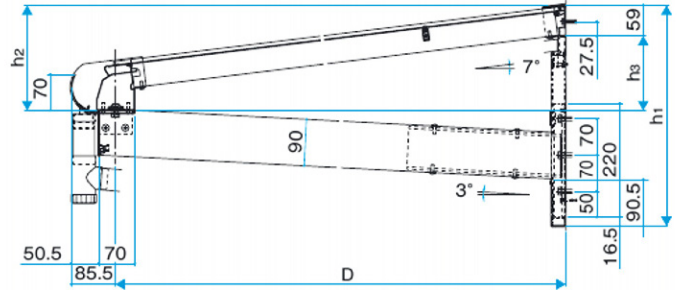

●TFBA型 (出幅2~4尺)

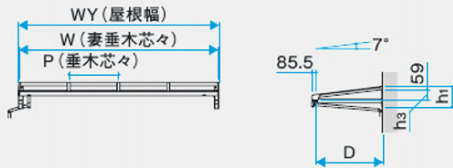

●TFBB型 (出幅2~4尺)

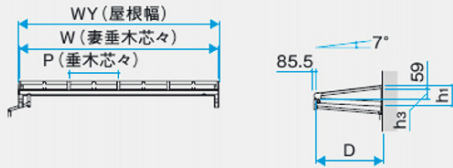

■間口 (W・WY)、垂木 (P)

(単位: mm)

間口	W	WY	垂木P	
			600タイプ	1500タイプ
0.5間 (30)	909	936	909	454.5
1.0間 (60)	1818	1845		
1.5間 (90)	2727	2754		
2.0間 (12)	3636	3663		
2.5間 (15)	4545	4572		
3.0間 (18)	5454	5481		
3.5間 (21)	6363	6390		
4.0間 (24)	7272	7299		
4.5間 (27)	8181	8208		
5.0間 (30)	9090	9117		
メーターモジュール	0.5間 (100)	1000	1000	500
	1.0間 (200)	2000		
	1.5間 (300)	3000		
	2.0間 (400)	4000		
	2.5間 (500)	5000		
	3.0間 (600)	6000		
	3.5間 (700)	7000		
	4.0間 (800)	8000		
	4.5間 (900)	9000		
	5.0間 (1000)	10000		

■ (600タイプ) 出幅 (D)、高さ (h1・h2・h3)

(単位: mm)

呼称出幅	D	h1	h2	h3
2尺 (20)	670	391	連結部:411	178
3尺 (30)	870	426	連結部:446	203
4尺 (40)	1170	478	連結部:498	240

●正面図<600タイプ>

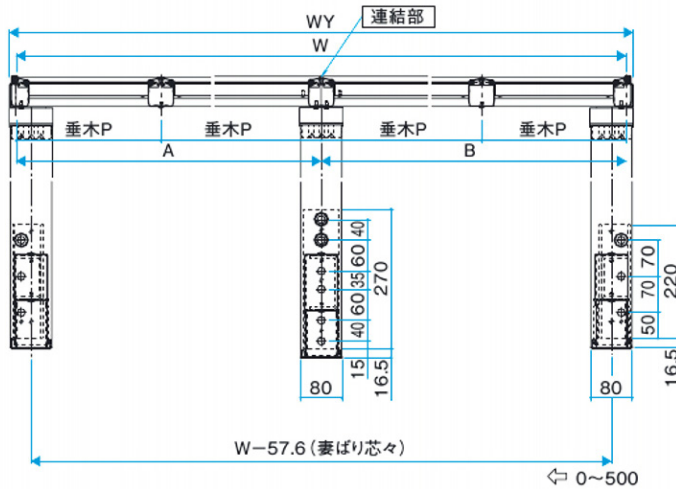

●側面図<1500タイプ>

